

CUTSHEET

Front View

Side View

Top View

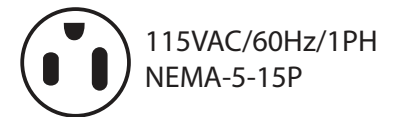
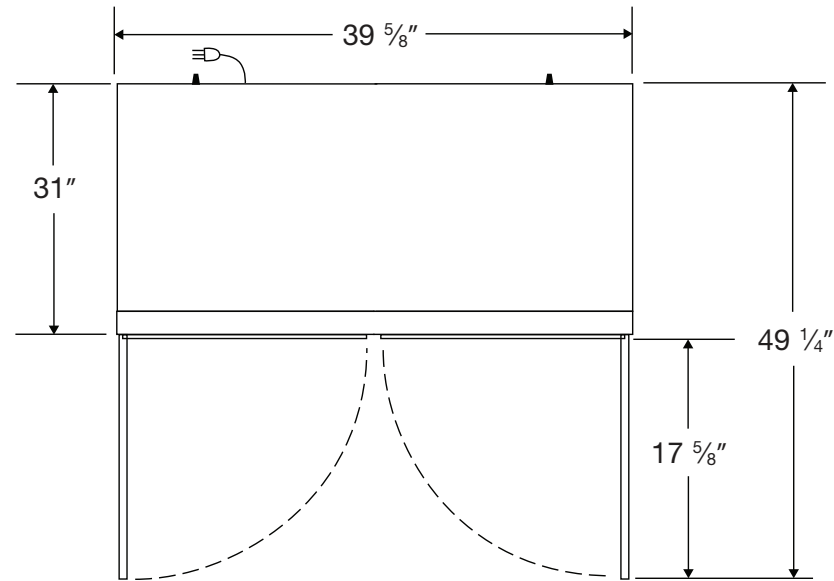
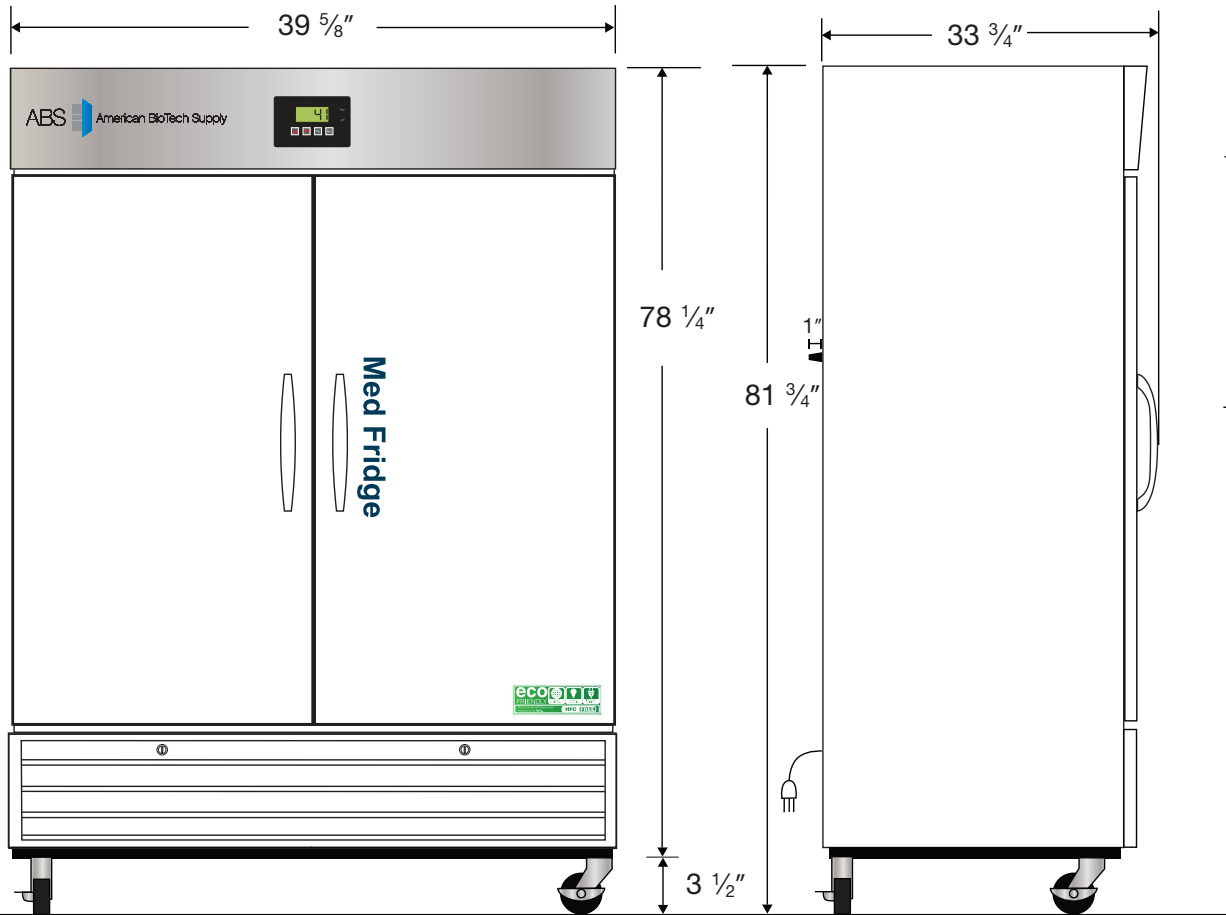

Cu. Ft	Defrost	Door	Int Door	Shelves	W"	D"	H"	Refrigerant	H.P.	Amps	Weight
36	Cycle	2 Solid	0	12 Adj.	39 5/8	34 3/4	81 3/4	R290	1/4	4.5	310 lbs.