

CUTSHEET

Front View

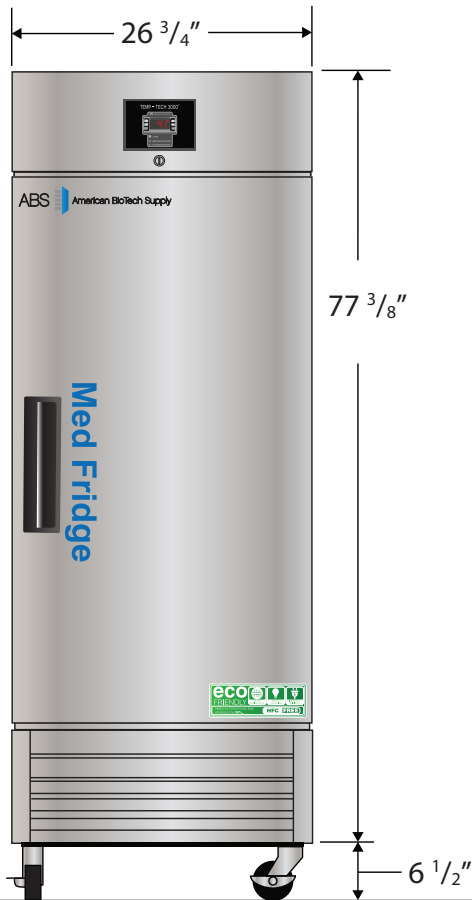

Side View

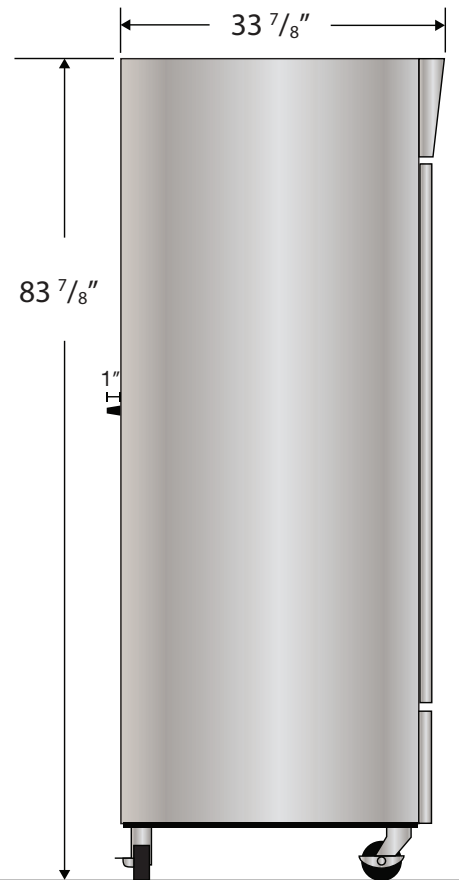

Top View

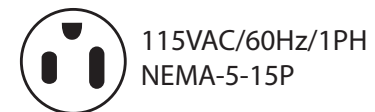
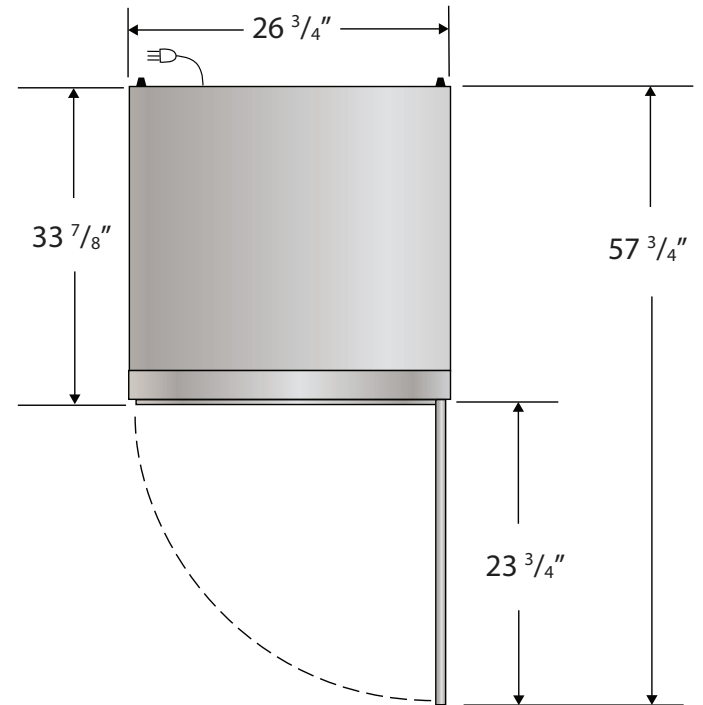

Cu. Ft	Defrost	Door	Int Door	Shelves	W"	D"	H"	Refrigerant	H.P.	Amps	Weight
23	Cycle	1 Solid	0	3 Adj.	26 3/4	34 7/8	83 7/8	R290	1/5	3	255 lbs.